

Absolute PL quantum yield spectrometer C9920-02,-02G,-03,-03G

Absolute value of the photoluminescence quantum yield can be instantaneously measured for thin films, solutions, and powders.



Absolute photo-luminescence quantum yield values as measured instantaneously for thin films, solutions and powders.

Developing luminescent and fluorescent materials requires improving their luminous efficiency. This in turn requires a precise measurement technique for determining their quantum yield (ration of emitted photons to absorbed photons). Our C9920-02, -02G, -03 and -03G Absolute PL quantum yield spectrometer employ the PL (Photoluminescence) method to measure absolute quantum yields quick and accurately.

Their setup comprises an excitation light source, monochromator, an integrating sphere capable of nitrogen gas flow and a CCD spectrometer for detecting the whole spectral range simultaneously. The dedicated software keeps operation easy. Two sample holders are available for thin films, powders and cuvettes holding liquid samples. This allows for the use of the C9920-02 and -03 systems in various fields like industry, biological and academic research.

The C9920 series also includes the C9920-12 which measures external quantum efficiencies of electroluminescent devices, and the C9920-11 which measures brightness and light distribution of the device. By adding the optional parts, power source meter, and dedicated measurement software to the C9920-02 and -03 configurations, it is possible to shift to the C9920-11 and C9920-12.

APPLICATIONS

◆ Development of organic LEDs

- PL quantum yields of basic materials
- Internal quantum efficiency measurements
- Quantum yields of thin films and devices

◆ Development of LEDs and Displays

- Inorganic LED materials
- Fluorescent materials for white light LEDs
- Fluorescent materials for flat panel displays (plasma display, field emission display etc.)

◆ Fundamental research

- Sample characterization in physical and chemical field
- Spectroscopy
- Fluorescence quantum yields
- Phosphorescence quantum yields

◆ Biological research

- Fluorescent probes
- Quantum dots



Absolute photoluminescence quantum yields (or internal quantum efficiency) are measured instantaneously.

The C9920-02, -02G, -03 and 03G systems employ the PL method for measuring absolute quantum yields (fluorescence or photoluminescence or internal quantum efficiency). The excitation wavelength is selected from the output of a xenon lamp by a monochromator. Various sample holders allow measurements of thin films, powder samples and solutions.

FEATURES

- Absolute quantum yield measurement of light emitting materials by PL method

- Measures total flux by incorporating an integration sphere.

Instantaneous measurement of the whole spectrum by employing a high sensitivity CCD sensor

- Measurements with ultra-high sensitivity and high signal-to-noise ratio

- For thin films, solutions and powder samples

- Temperature control

- Automatic control of excitation wavelength
(C9920-02G, -03G)

- Absolute quantum yield measurement of solutions at 77 K (C9920-02G, -03G)

- Various of analysis functions

- Quantum yield measurement
- Excitation wavelength dependability (C9920-02G, 03G)
- Emission spectrum
- PL excitation spectrum spectrum (C9920-02G, 03G)

SELECTION

PL measurement wavelength range		300 nm to 950 nm	400 nm to 1100 nm
Excitation wavelength control	Manual	C9920-02	C9920-03
	Automatic	C9920-02G	C9920-03G

C9920-02, -03 configuration example

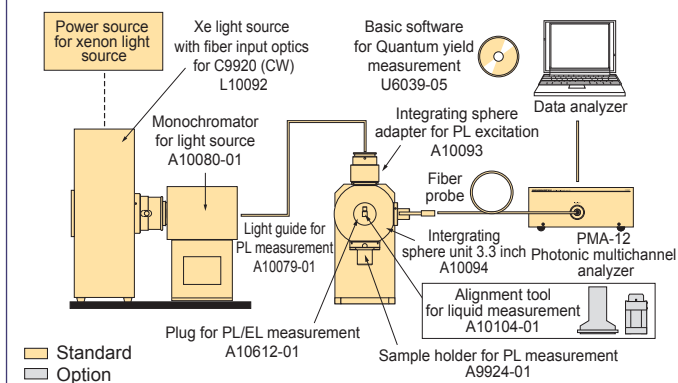

C9920-02G, -03G configuration example

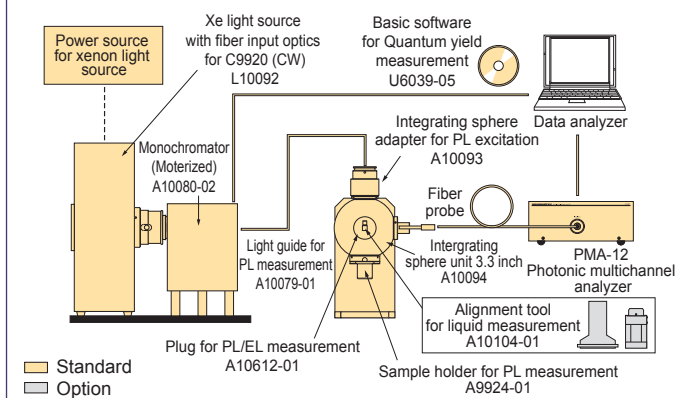

We offer sample holder for thin films, powders, as well as solutions to support a wide variety of applications.

Example of measurements

Phosphorescence quantum yield of phosphorescent materials for organic LED

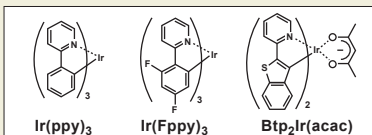
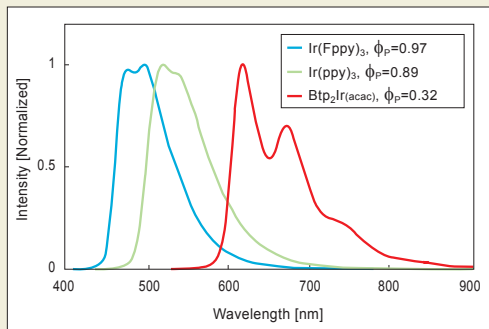

Iridium complex is the focal point of much recent research as a promising phosphorescent material for organic LEDs. We measured its phosphorescence quantum yield (ϕ_p) in dichloroethane solution. Results showed the blue material Ir(Fppy)₃ and green material Ir(ppy)₃ respectively indicate high ϕ_p values of approximately 0.97 and 0.89. The red material Btp₂Ir(acac), on the other hand, yielded a low ϕ_p value of approximately 0.32. Since these phosphorescent materials form a triplet state with an efficiency of about 100 %, the decrease in ϕ_p in Btp₂Ir(acac) is clearly due to efficient intersystem crossing from T₁ to S₀ (in other words, a non-radiating transition from a triplet state T₁ to a ground state S₀).

Collaborative research of Hamamatsu Photonics K.K.; Adachi lab, CFC, Kyushu University; and Tobita lab, Faculty of Engineering, Gunma University. A. Endo, K. Suzuki, T. Yoshihara, S. Tobita, M. Yahiro, and C. Adachi, *Chem. Phys. Lett.*, **460**, 155 (2008).

Observing high-efficiency intermolecular energy transfer in rare-earth complex

Energy transfer efficiency Ligand → f-level >80 %

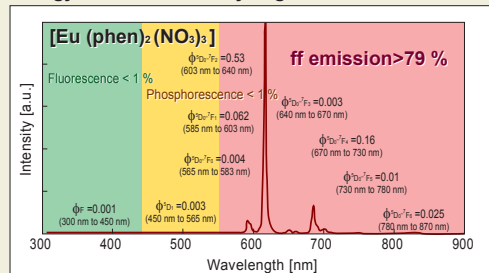

Rare-earth complexes are attracting much recent attention as a "clean energy conversion material utilizing ligands for efficient photo-excited energy conversion" that "emits light having a sharp peak in the visible region." We measured the emission quantum yield of rare-earth complex [Eu(phen)₂(NO₃)₃] in a powder state. Direct excitation on the 1,10-phenanthroline (Phen) resulted in a europium (Eu) emission quantum yield of approximately 0.8. No luminescence from Phen was observed, so we conclude that energy transfer from Phen to Eu occurred at a high efficiency of over 80 %.

Courtesy of Dr. Miki Hasegawa, Aoyama Gakuin University

Fluorescence quantum yield and levigation effect on p-terphenyl and anthracene single crystals

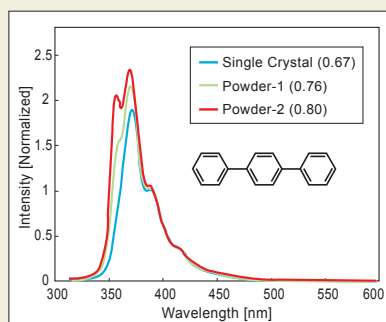

Figure A: Fluorescence spectrum of p-terphenyl

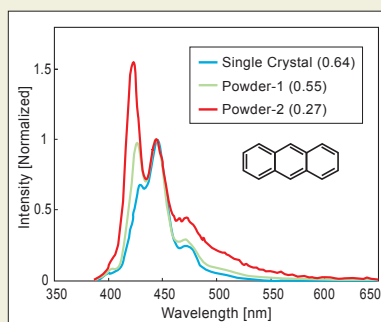

Figure B: Fluorescence spectrum of anthracene single crystal

We utilized high-purity single crystals of the typical organic materials p-terphenyl and anthracene to determine their respective fluorescence quantum yields. Measuring the p-terphenyl resulted in a fluorescence quantum yield of 0.67 for this high-purity single crystal (blue curve in Figure A). Levigating this single crystal to a fine powder increased the fluorescence quantum yield to 0.80 (red curve in Figure A). On the other hand, levigating the high-purity, single crystal anthracene decreased the fluorescence quantum yield from 0.64 to 0.27 (Figure B). Measuring the p-terphenyl showed a higher fluorescence quantum yield and appearance of structures on the short wavelength side of the fluorescence spectrum. So this higher fluorescence quantum yield was possibly caused by the fine powder from levigation that acts to inhibit reabsorption. Examining the anthracene revealed another luminescent component at longer wavelengths caused by levigation in addition to the usual luminescent components on shorter wavelengths of the fluorescence spectrum. This luminescent component on the lower wavelengths resembles the fluorescence spectrum of anthracene dimer and so was found to be luminescence from a dimer state. This fact proves that the decrease in fluorescence quantum yield of anthracene single crystal was caused by dimers induced by levigation that formed structural flaws and acted as a center for light extinction.

Collaborative research of Hamamatsu Photonics K.K.; Ryuzi Katoh, Akihiro Furube, Ph.D., Research Institute of Instrumentation Frontier, Advanced Industrial Science and Technology; Masahiro Kotani, Ph.D., Department of Chemistry, Gakushuin University; and Katsumi Tokumaru, University of Tsukuba. R. Katoh, K. Suzuki, A. Furube, M. Kotani, and K. Tokumaru, *J. Phys. Chem. C*, **113**, 2961(2009).

Potential applications in diverse fields including biology

Example of measurements

Re-evaluation of luminescence quantum yield of representative standard solutions

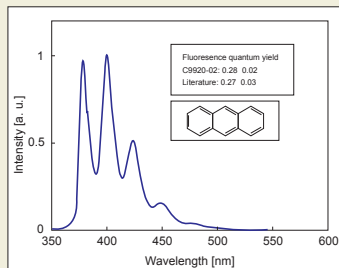

The C9920-0X (X=2,3) consists of an excitation light source, an integrating sphere and a multichannel spectrometer, and measures the absolute photoluminescence quantum yield. By using the C9920-0X, the quantum yields of fluorescence standard compounds in solution were measured. The compounds are commonly used as fluorescence standards in quantum yield measurements based on a relative method. For most of the compounds, the quantum yield measured by the C9920-0X shows excellent agreement with the values given in the literature, proving the high reliability of the C9920-0X.

Figure: Fluorescence spectrum and quantum yield of anthracene solution

Collaborative research of Hamamatsu Photonics K.K.; Tobita lab, Faculty of Engineering, Gunma University; and H. Ishida, School of Science, Kitasato University. K. Suzuki, A. Kobayashi, S. Kaneko, K. Takehira, T. Yoshihara, H. Ishida, Y. Shiina, S. Oishi, and S. Tobita, *Phys. Chem. Chem. Phys.*, **11**, 9850 (2009).

Quantum yield measurement of fluorescent bioprobe

Fluorescent probe for enzyme reaction detection: Quantum yield provides a comparative measurement.

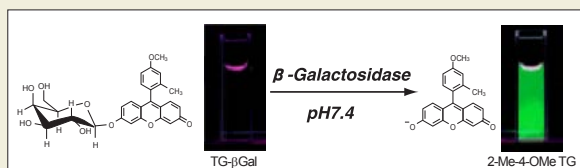

Compounds	Fluorescence quantum yield
TG-βGal	0.01
2-Me-4-OMe TG	0.72

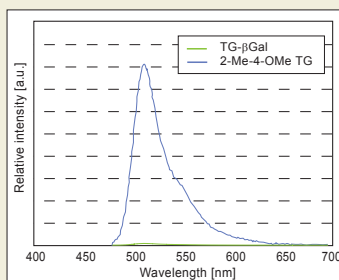

Fluorescent probe TG (Tokyo Green) -βGal for β-galactosidase activity detection is nonluminescent ($\phi_f = 0.01$) but exhibits strong fluorescence after reacting with β-galactosidase. The quantitative difference in amounts of light emitted before and after the enzyme reaction can be found by comparing their quantum yields ϕ_f .

Courtesy of Yasuteru Urano, Ph.D., Graduate School of Medicine, University of Tokyo.

Fluorescent material (BAM) for white LED

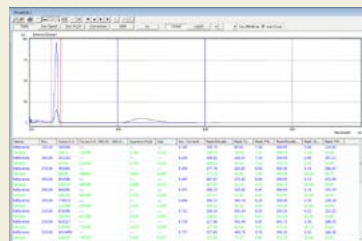

BAM measurement display

This example is a BAM measurement obtained in the C9920-02G wavelength scan mode. It shows luminescence quantum yield values at each excitation wavelength as well as excitation light and sample emission intensities, peak wavelengths, and peak counts, etc.

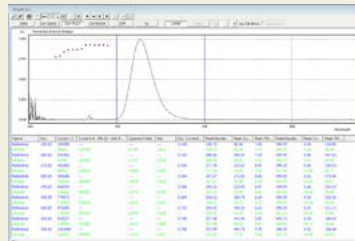

BAM powder data

This graph shows the BAM luminescence quantum yield versus the excitation wavelength. It proves that BAM luminescence quantum yield values differ according to the excitation wavelength.

Phosphorescence quantum yield measurement of benzophenone at -196 °C (77K)

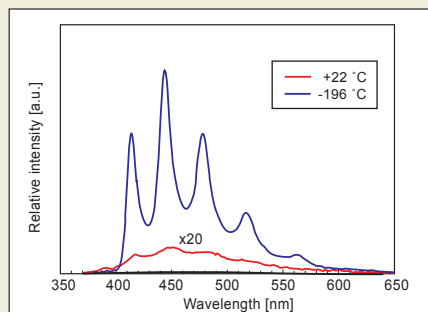

Example of measurement

Phosphorescence quantum yields in benzophenone organic solution were measured at room temperature (22 °C (295 K)) and at a low temperature (-196 °C (77 K)) and both compared on the graph. Benzophenone is known to generate a triplet excitation state at a high efficiency (ϕ_{ISC} to 1.0) after being excited by light from the ground state to the singlet state. Observing phosphorescence from general organic compounds is usually difficult because phosphorescence is a forbidden transition. In benzophenone, a phosphorescence spectrum, though weak, was definitely observed (ϕ_P to 0.01). The result also shows that phosphorescent intensity greatly increased at low temperature compared to room temperature and produced a high phosphorescence quantum yield ($\phi_P > 0.8$).

Collaborative research of Hamamatsu Photonics K.K. and Tobita lab, Faculty of Engineering, Gunma University.

Product lineup includes 4 types of systems to match diverse user needs.

SPECIFICATIONS

■ C9920-02, -02G, -03, -03G

Type number	C9920-02	C9920-02G	C9920-03	C9920-03G
PL measurement Wavelength range	300 nm to 950 nm		400 nm to 1100 nm	
Monochromatic light source				
Light source	150 W Xenon light source			
Excitation wavelength	250 nm to 800 nm	250 nm to 950 nm	375 nm to 800 nm	375 nm to 1000 nm
Bandwidth	10 nm or less (FWHM)	Approx. 2 nm to 5 nm (Varies with slit)	10 nm or less (FWHM)	Approx. 2 nm to 5 nm (Varies with slit)
Degradation prevention of the sample by light	Excitation light interception by the mechanical shutter			
Excitation wavelength control	Manual	Automatic control	Manual	Automatic control
Multichannel spectroscope				
Measurement wavelength range	200 nm to 950 nm		350 nm to 1100 nm	
Wavelength resolution	<2 nm		<2.5 nm	
Number of photosensitive device channels	1024 ch			
Device cooling temperature	-15 °C			
AD resolution	16 bit			
Spectroscope optical arrangement	Czerny-Turner type			
Fiber type	Bundled fiber (1.5 m)			
Fiber receiving area	Φ1 mm			
Integrating sphere				
Material	Spectralon			
Size	3.3 inch			
Sample holder (Option)				
Thin film	Using Laboratory dish without caps (5 sets) A10095-01 (not including a substrate)			
Powder	Using Laboratory dish with caps (5 sets) A10095-03			
Solution (normal temperature)	Using Alignment tool for liquid measurement A10104-01			
Solution (low temperature)	-196 °C (77 K) by using Sample holder for low temperature A11238-01			
Temperature control	RT* to +180 °C by using Sample holder for temperature control A9924-18			
Sample case (Option)				
Powder	Using Laboratory dish with caps (5 sets) A10095-03			
Solution (normal temperature)	Using Side-arm cell (3 sets) A10095-02			
Solution (low temperature)	-196 °C (77 K) by using Sample tube for low temperature measurement (5 pcs) A10095-04			
Software				
Measurement items	PL quantum yield			
	Fluorescent materials luminance efficiency measurement (quantum yield x absorption)			
	Excitation wavelength dependence of quantum yield (-02G, -03G)			
	PL spectrum (peak wavelength, FWHM)			
	PL excitation spectrum (-02G, -03G)			
	Color measurement (chromaticity, color temperature, color rendering index, etc.)			
Self-absorption correction (Optics for transmission and fluorescence measurement A11238-03 is required)				

* RT: Room temperature

■ Data analyzer (Option)

Type number	C10471-01	C10471-02
OS	Windows 7	
Interface	USB	
Type	Laptop	Desktop

Optional components for additional flexibility

OPTIONS

Sample holder

For solution

- **Alignment tool for liquid measurement**
A10104-01
- **Sample holder for low temperature**
A11238-01
This is used to cool the sample solution with liquid nitrogen.
- **Optics for transmission and fluorescence measurement**
A11238-03
Optical systems that measure luminescence spectrum of solutions in liquid nitrogen.

For powder

- **Sample holder for temperature control**
A9924-18
This option allows setting the maximum temperature of powder samples up to 180 °C.
Measurements can now be made in environments where phosphors for white LED are actually used.
Temperature control range: RT to +180 °C
* This sample holder also requires dedicated TE control unit.

Sample case

For solution

- **Side-arm cell (3 sets)**
A10095-02
- **Sample tube for low temperature measurement (5 pcs)**
A10095-04
This is used to measure a sample solution at liquid nitrogen temperature.

For powder

- **Laboratory dish**
without caps (5 sets) A10095-01
with caps (5 sets) A10095-03
This is used for making measurements on thin film and powder samples. This is a five-piece set made of synthetic quartz, which suppresses fluorescence and luminescence.



Excitation light source

Adapter for LED excitation

- **Adapter for LED light source**
A11133
This adapter excites the sample by using an LED. It supports both bullet type and SMD type LED. LED and its driver power supply should be prepared by the user.



Upgradable to C9920-02G, -03G from C9920-02, -03

Spectroscopy

- **Monochromator (Motorized)**
A10080-02
Possible to select the wavelength of xenon light source. A monochromator transmits light wavelength for measuring the excitation wavelength dependence of the luminescence quantum yield and the PL excitation spectrum.
Excitation wavelength: 250 nm to 1000 nm
Bandwidth: Approx. 2 nm to 5 nm (varies with slit)



Spare parts

- **Sample holder for PL measurement**
A9924-01
This is an additional sample holder. The C9920-02, -02G, -03, and -03G includes one A9924-01 as a standard.
- **Dewar for low temperature**
A11238-02
This is a dewar flask for cooling sample solutions with liquid nitrogen.
- **Spare part for A9924-01**
A11372-01
- **Spare part for A10612-01 (for solution)**
A11372-02



- **Xe lamp**
L8474
This is a replacement bulb for the xenon excitation light source.
- **Sensitivity calibration**
To maintain high-precision measurements, we recommend periodically reacquiring sensitivity correction data.
- **PMA-12 (detector) shutter addition**
When using a PMA-12 (detector) that you already have for measuring organic electroluminescence quantum yields, the addition of a function for external shutter control is necessary.



Systems for fluorescence lifetime measurements

Related Products

Fluorescence lifetime of a substance is closely related to the quantum yield and is an important parameter for elucidating the photophysical process. By combining our ultra-low light level measurement with spectrophotometric technologies, we offer advanced systems optimized for measurements in the UV to near infrared region.

● Picosecond fluorescence lifetime measurement system C11200-01

Combining a laser with a streak camera allows measuring fluorescence and phosphorescence lifetimes ranging from picoseconds to milliseconds over a wide dynamic range. Fluorescence and phosphorescence components can be captured visually since measurement results are observed as 2D images along the wavelength axis and time axis.



Temporal Luminescent spectrum measurement of phosphorescent components

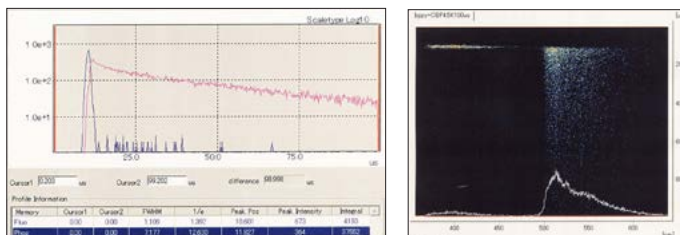

▲ Phosphorescence materials Ir(ppy)₃:
Fluorescence, phosphorescence and streak image of temporal resolution luminescent spectra of host CBP thin film at 4.5 K

Courtesy of Chihaya Adachi, Ph.D., CFC, Kyushu University

● Compact NIR PL lifetime spectrometer C12132 series

C12132 series is designed for measuring photoluminescence (PL) spectrum and PL lifetime in the NIR region (580 nm to 1400 nm).

A YAG laser is also included in the main unit.



Measure carrier lifetime and emission spectrum of a compound semiconductor

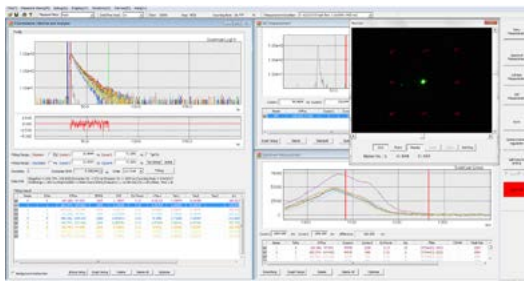

- Product and software package names noted in this documentation are trademarks or registered trademarks of their respective manufacturers.
- Subject to local technical requirements and regulations, availability of products included in this promotional material may vary. Please consult your local sales representative.
- Information furnished by HAMAMATSU is believed to be reliable. However, no responsibility is assumed for possible inaccuracies or omissions.

Specifications and external appearance are subject to change without notice.

© 2017 Hamamatsu Photonics K.K.

HAMAMATSU PHOTONICS K.K. www.hamamatsu.com

HAMAMATSU PHOTONICS K.K., Systems Division

812 Joko-cho, Higashi-ku, Hamamatsu City, 431-3196, Japan, Telephone: (81)53-431-0124, Fax: (81)53-435-1574, E-mail: export@sys.hpk.co.jp

U.S.A.: Hamamatsu Corporation, 360 Foothill Road, Bridgewater, NJ 08807, U.S.A., Telephone: (1)908-231-0960, Fax: (1)908-231-1218 E-mail: usa@hamamatsu.com

Germany: Hamamatsu Photonics Deutschland GmbH: Arzbergerstr. 10, D-82211 Herrsching am Ammersee, Germany, Telephone: (49)8152-375-0, Fax: (49)8152-265-8 E-mail: info@hamamatsu.de

France: Hamamatsu Photonics France S.A.R.L.: 19, Rue du Saule Trapu, Parc du Moulin de Massy, 91882 Massy Cedex, France, Telephone: (33)1 69 53 71 00, Fax: (33)1 69 53 71 10 E-mail: info@hamamatsu.fr

United Kingdom: Hamamatsu Photonics UK Limited: 2 Howard Court, 10 Tewin Road, Welwyn Garden City, Hertfordshire AL7 1BW, UK, Telephone: (44)1707-294888, Fax: (44)1707-325777 E-mail: info@hamamatsu.co.uk

North Europe: Hamamatsu Photonics Norden AB: Torshamnsgatan 35 16440 Kista, Sweden, Telephone: (46)8-509-031-00, Fax: (46)8-509-031-01 E-mail: info@hamamatsu.se

Italy: Hamamatsu Photonics Italia S.r.l.: Strada della Moia, 1 int. 6, 20020 Arese (Milano), Italy, Telephone: (39)02-935-81-733, Fax: (39)02-935-81-741 E-mail: info@hamamatsu.it

China: Hamamatsu Photonics (China) Co., Ltd.: 1201 Tower B, Jiaming Center, 27 Dongsanhuan Beilu, Chaoyang District, 100020 Beijing, China, Telephone: (86)10-6586-6006, Fax: (86)10-6586-2866 E-mail: hpc@hamamatsu.com.cn

Taiwan: Hamamatsu Photonics Taiwan Co., Ltd.: 8F-3, No.158, Section2, Gongdao 5th Road, East District, Hsinchu, 300, Taiwan R.O.C. Telephone: (886)03-659-0080, Fax: (886)07-811-7238 E-mail: info@tw.hpk.co.jp

Cat. No. SSMS0015E14
JAN/2017 HPK
Created in Japan